

8 7 6 5 4 3 2 1

D

D

C

C

B

B

A

A

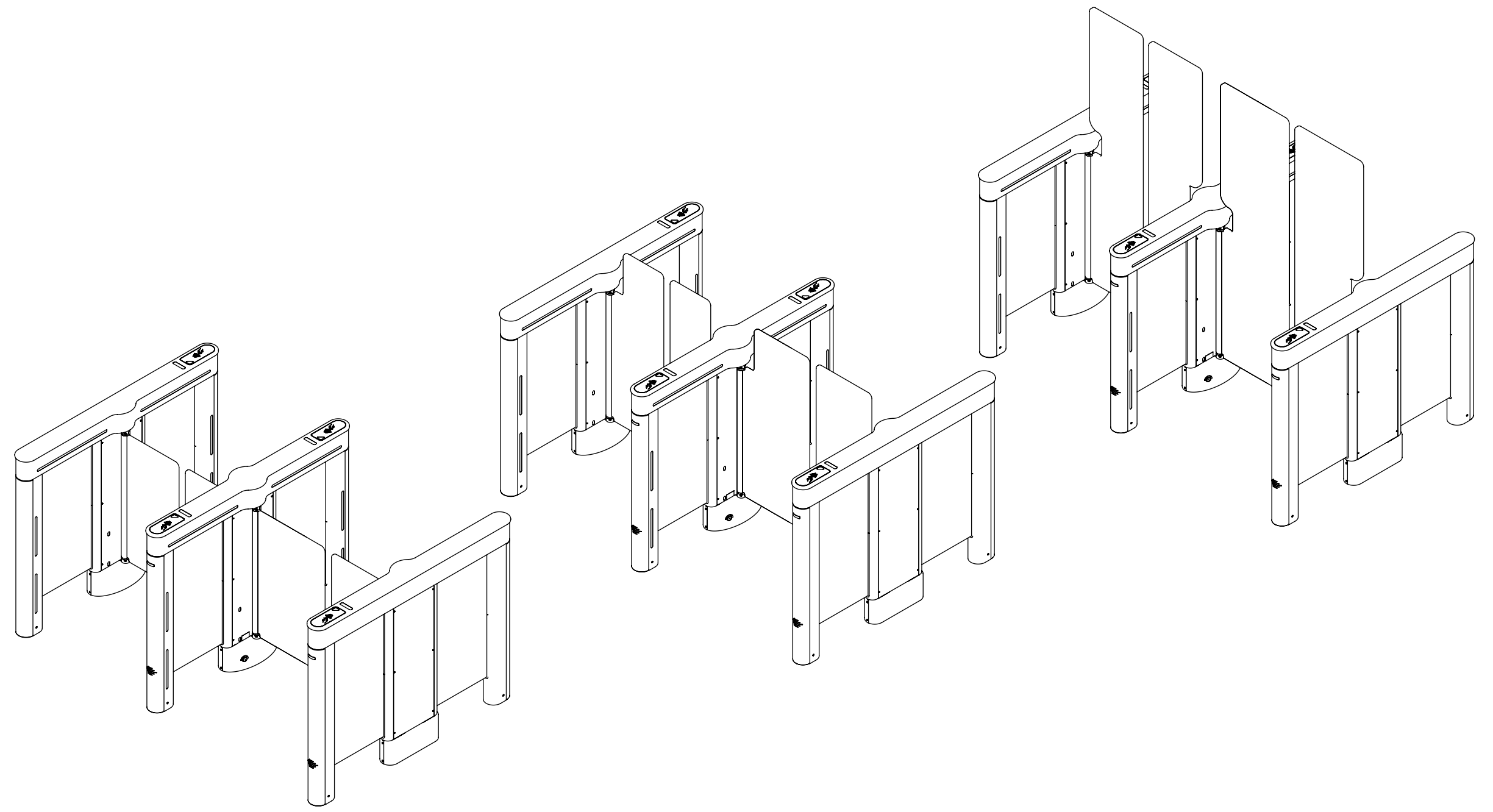

APPROVED BY: _____

DATE: _____

NOTES:

1. ALL DIMENSIONS ARE APPROXIMATE AND IN INCHES [mm].
2. ALVARADO RECOMMENDS 28" WIDTH LANES BE USED FOR GENERAL PURPOSE ENTRY/EXIT CONTROL. ALVARADO RECOMMENDS 36" WIDTH LANES BE RESERVED FOR USE BY PATRONS WITH SPECIAL REQUIREMENTS.
3. MULTIPLE BARRIER SIZES SHOWN FOR ILLUSTRATION ONLY. CUSTOMER TO CHOOSE BARRIER HEIGHT PER ORDER.

THIRD ANGLE PROJECTION



PROPRIETARY AND CONFIDENTIAL

THE INFORMATION CONTAINED IN THIS DRAWING IS THE SOLE PROPERTY OF ALVARADO MANUFACTURING INC. ANY REPRODUCTION IN PART OR AS A WHOLE WITHOUT THE WRITTEN PERMISSION OF ALVARADO MANUFACTURING INC. IS PROHIBITED.

DO NOT SCALE DRAWING

ALVARADO
 12660 Colony Street, Chino, CA 91710
 909.591.8431 - 909.628.1403 (Fax)
 www.alvaradomfg.com

TITLE:
SU5000 36"/28" LANES LAYOUT (R TO L)

	NAME	DATE	SIZE	DWG. NO.	REV
DRAWN	MRP	1/17/2020	B	PEF-1111	B
CHECKED					
ENGR	RPL	12/30/2019	SCALE: 1:22	SHEET 1 OF 5	

8 7 6 5 4 3 2 1

8 7 6 5 4 3 2 1

D

D

C

C

B

B

A

A

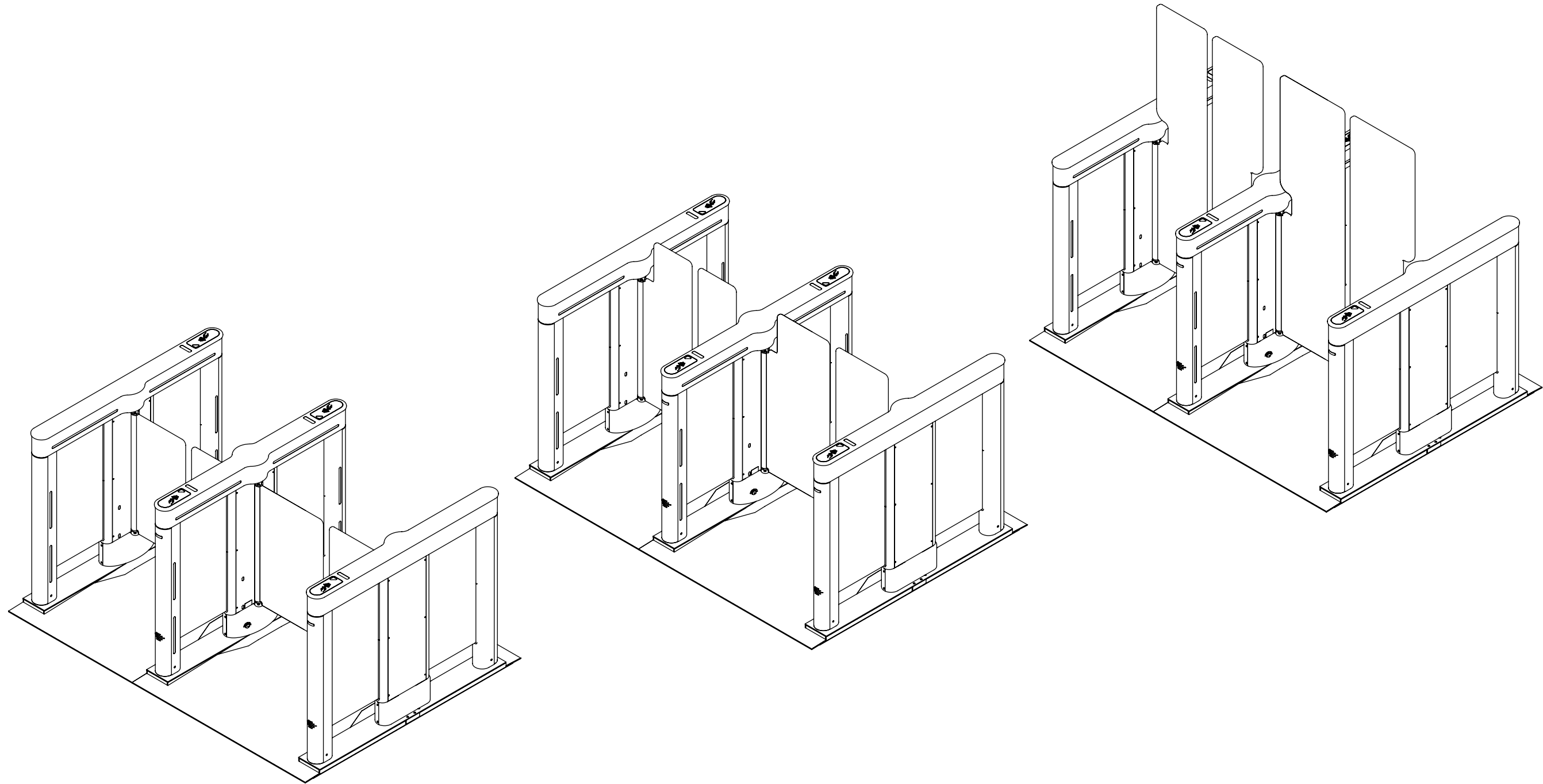

8 7 6 5 4 3 2 1

THIRD ANGLE PROJECTION

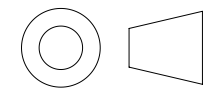

PROPRIETARY AND CONFIDENTIAL

THE INFORMATION CONTAINED IN THIS DRAWING IS THE SOLE PROPERTY OF ALVARADO MANUFACTURING INC. ANY REPRODUCTION IN PART OR AS A WHOLE WITHOUT THE WRITTEN PERMISSION OF ALVARADO MANUFACTURING INC. IS PROHIBITED.

DO NOT SCALE DRAWING



Alvarado Mfg. Co. Inc.
12660 Colony Street, Chino, CA 91710
909.591.8431 - 909.628.1403 (Fax)
www.alvaradomfg.com

TITLE:
SU5000 36"/28" LANES LAYOUT (R TO L)

	NAME	DATE	SIZE	DWG. NO.	REV
DRAWN	MRP	1/17/2020	B	PEF-1111	B
CHECKED					
ENGR	RPL	12/30/2019	SCALE: 1:22	SHEET 2 OF 5	

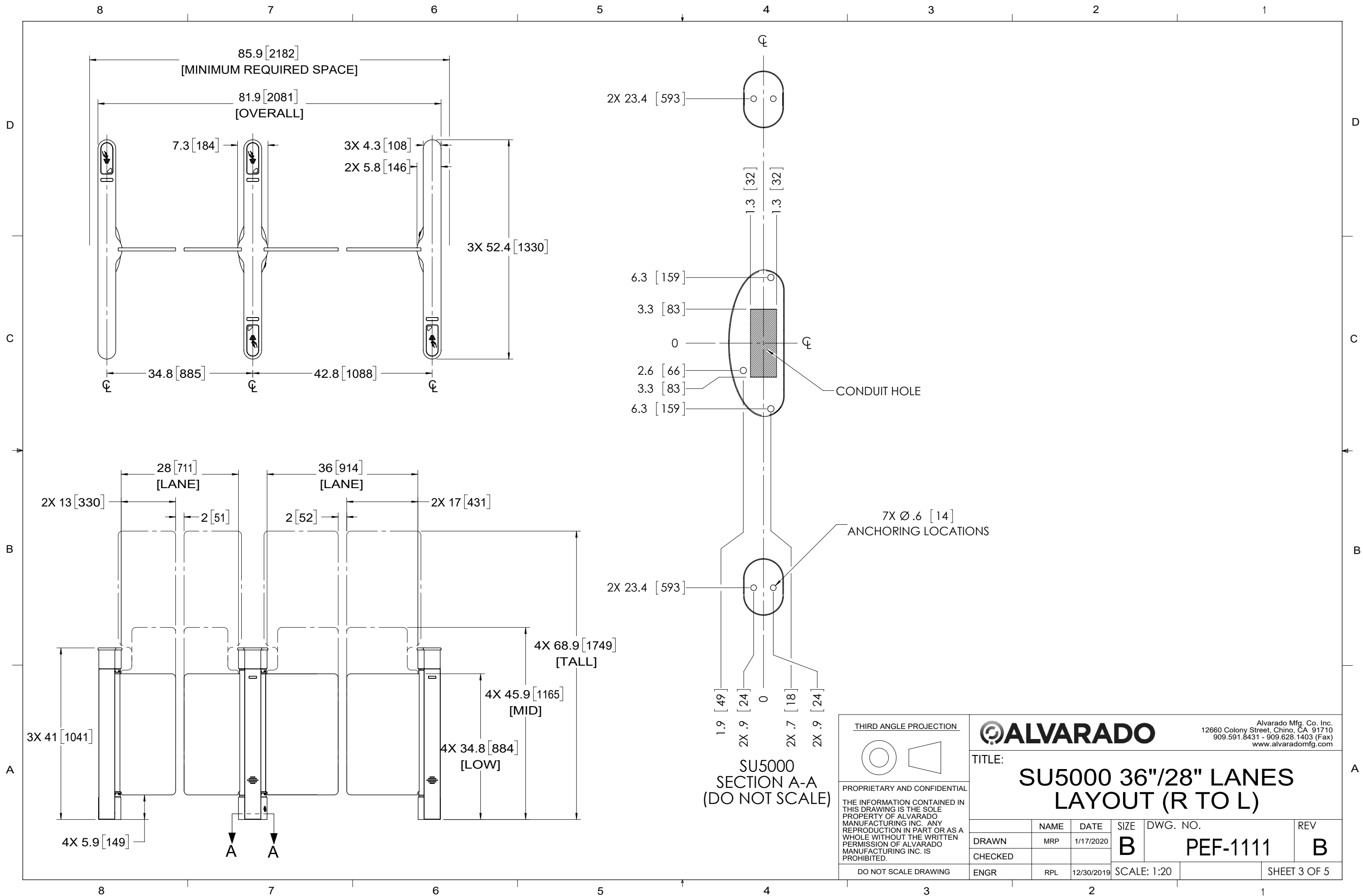

85.9 [2182]
[MINIMUM REQUIRED SPACE]

81.9 [2081]
[OVERALL]

7.3 [184]

3X 4.3 [108]
2X 5.8 [146]

3X 52.4 [1330]

34.8 [885]

42.8 [1088]

28 [711]
[LANE]

36 [914]
[LANE]

2X 13 [330]

2 [51]

2 [52]

2X 17 [431]

4X 68.9 [1749]
[TALL]

4X 45.9 [1165]
[MID]

4X 34.8 [884]
[LOW]

3X 41 [1041]

4X 5.9 [149]

A A

2X 23.4 [593]

Φ

1.3 [32]

1.3 [32]

6.3 [159]

3.3 [83]

0

2.6 [66]

3.3 [83]

6.3 [159]

Φ

CONDUIT HOLE

7X Ø.6 [14]
ANCHORING LOCATIONS

2X 23.4 [593]

1.9 [49]

2X .9 [24]

0

2X .7 [18]

2X .9 [24]

SU5000
SECTION A-A
(DO NOT SCALE)

THIRD ANGLE PROJECTION

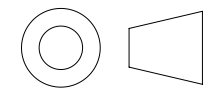

PROPRIETARY AND CONFIDENTIAL

THE INFORMATION CONTAINED IN THIS DRAWING IS THE SOLE PROPERTY OF ALVARADO MANUFACTURING INC. ANY REPRODUCTION IN PART OR AS A WHOLE WITHOUT THE WRITTEN PERMISSION OF ALVARADO MANUFACTURING INC. IS PROHIBITED.

DO NOT SCALE DRAWING

ALVARADO

Alvarado Mfg. Co. Inc.
12660 Colony Street, Chino, CA 91710
909.591.8431 - 909.628.1403 (Fax)
www.alvaradomfg.com

TITLE:
**SU5000 36"/28" LANES
LAYOUT (R TO L)**

	NAME	DATE	SIZE	DWG. NO.	REV
DRAWN	MRP	1/17/2020	B	PEF-1111	B
CHECKED					
ENGR	RPL	12/30/2019	SCALE: 1:20		SHEET 3 OF 5

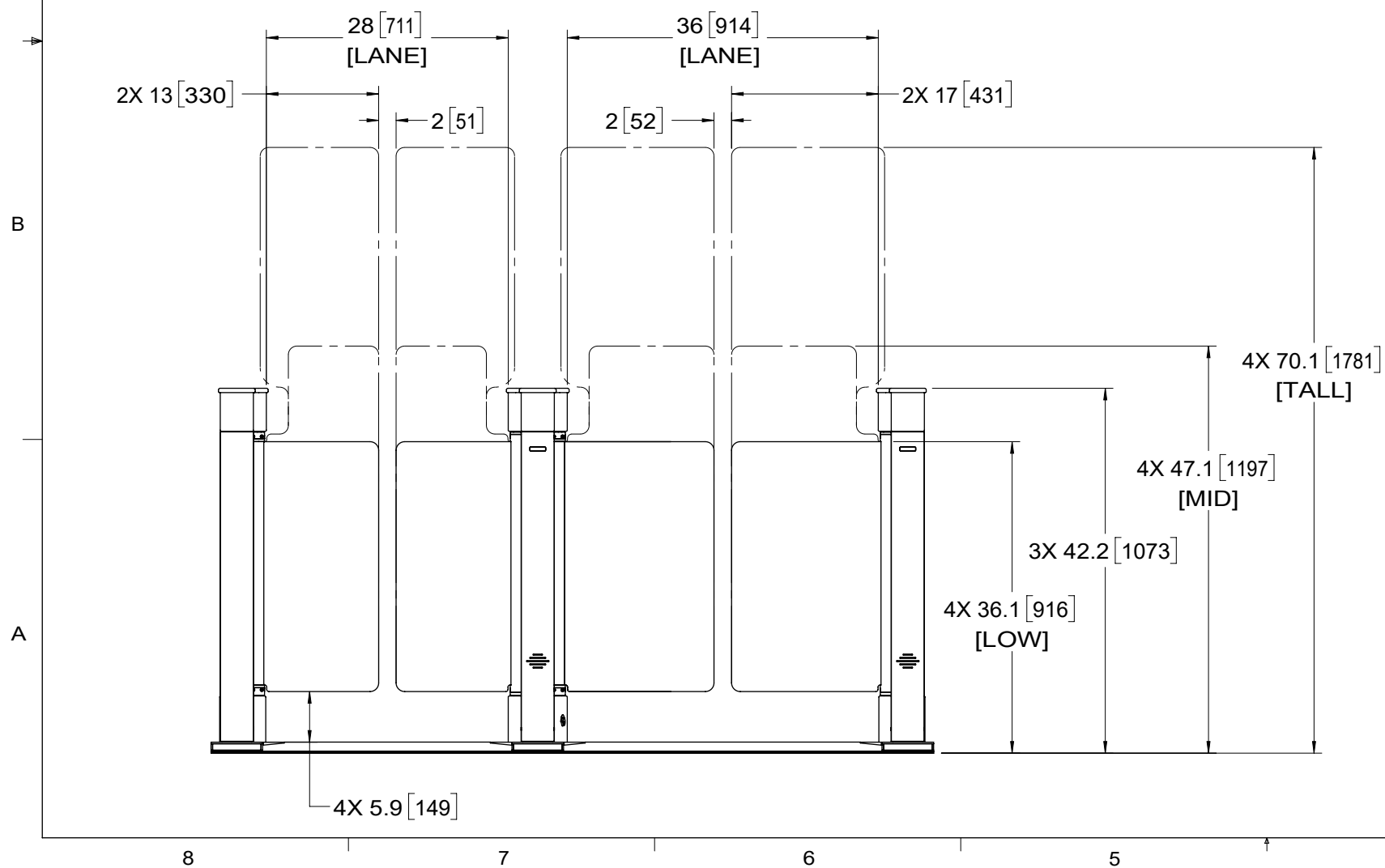
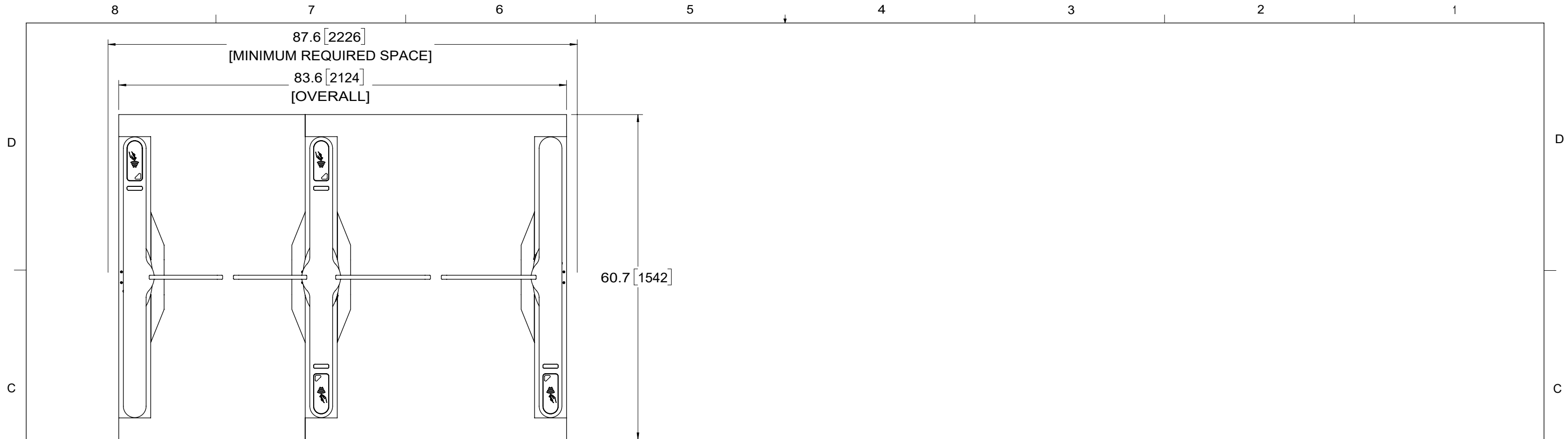

<p>THIRD ANGLE PROJECTION</p>		<p>ALVARADO</p> <p>Alvarado Mfg. Co. Inc. 12660 Colony Street, Chino, CA 91710 909.591.8431 - 909.628.1403 (Fax) www.alvaradomfg.com</p>	
<p>PROPRIETARY AND CONFIDENTIAL</p> <p>THE INFORMATION CONTAINED IN THIS DRAWING IS THE SOLE PROPERTY OF ALVARADO MANUFACTURING INC. ANY REPRODUCTION IN PART OR AS A WHOLE WITHOUT THE WRITTEN PERMISSION OF ALVARADO MANUFACTURING INC. IS PROHIBITED.</p>			
<p>TITLE: SU5000 36"/28" LANES LAYOUT (R TO L)</p>			
<p>DRAWN</p> <p>CHECKED</p> <p>ENGR</p>	<p>NAME</p> <p>MRP</p> <p>RPL</p>	<p>DATE</p> <p>1/17/2020</p> <p>12/30/2019</p>	<p>SIZE</p> <p>B</p> <p>SCALE: 1:18</p>
<p>DWG. NO.</p> <p>PEF-1111</p>		<p>REV</p> <p>B</p> <p>SHEET 4 OF 5</p>	

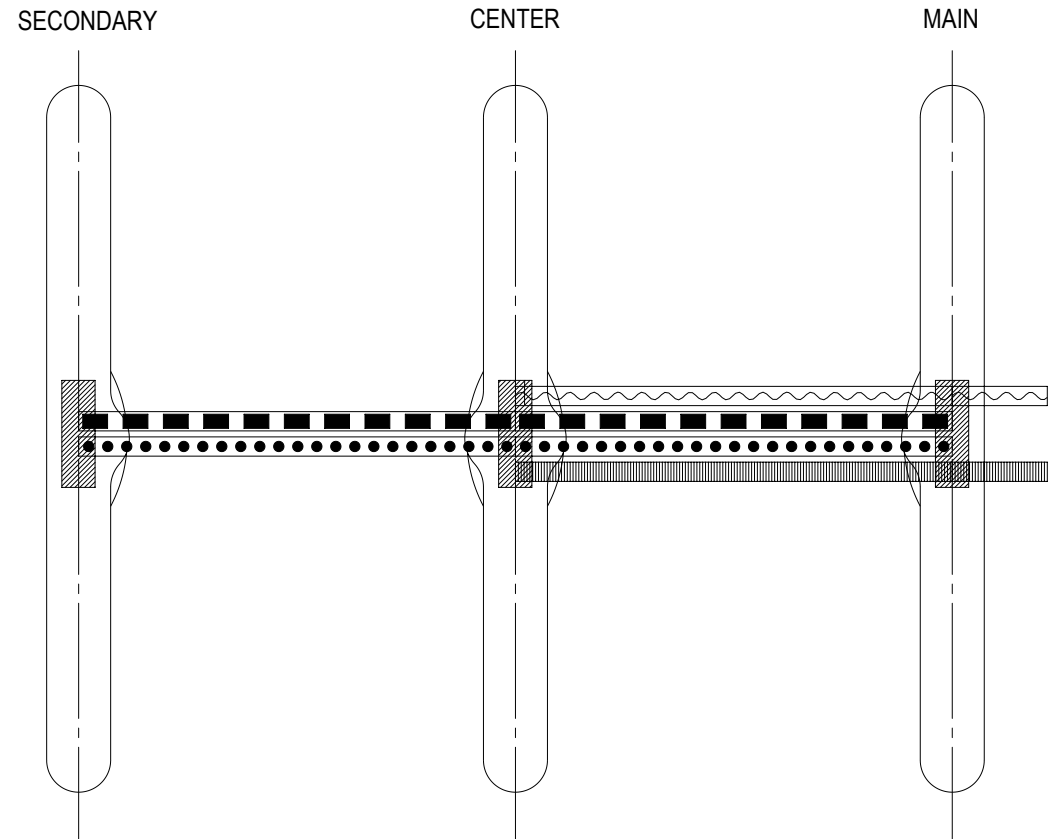

Symbology	Description	Conduit Size
	Primary Power**	3/4" (1/2")
	Access Control / Ethernet	3/4"
	Access Control	3/4"
	Crossover Cable	1.5"

**If using the External DC Power Supply option, use this conduit to route 24VDC.

THIRD ANGLE PROJECTION

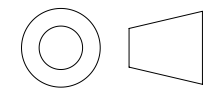

PROPRIETARY AND CONFIDENTIAL
 THE INFORMATION CONTAINED IN THIS DRAWING IS THE SOLE PROPERTY OF ALVARADO MANUFACTURING INC. ANY REPRODUCTION IN PART OR AS A WHOLE WITHOUT THE WRITTEN PERMISSION OF ALVARADO MANUFACTURING INC. IS PROHIBITED.

DO NOT SCALE DRAWING



Alvarado Mfg. Co. Inc.
 12660 Colony Street, Chino, CA 91710
 909.591.8431 - 909.628.1403 (Fax)
 www.alvaradomfg.com

TITLE:
SU5000 36"/28" LANES LAYOUT (R TO L)

	NAME	DATE	SIZE	DWG. NO.	REV
DRAWN	MRP	1/17/2020	B	PEF-1111	B
CHECKED					
ENGR	RPL	12/30/2019	SCALE: 1:16	SHEET 5 OF 5	